

DETAIL A  
SCALE 1 : 2

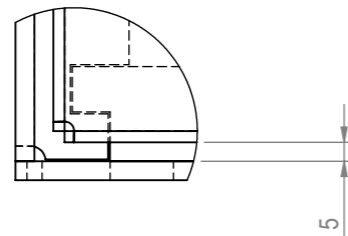

DETAIL B  
SCALE 1 : 2

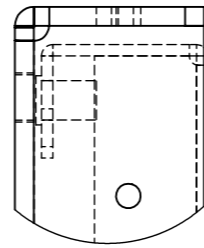

DETAIL D  
SCALE 1 : 2

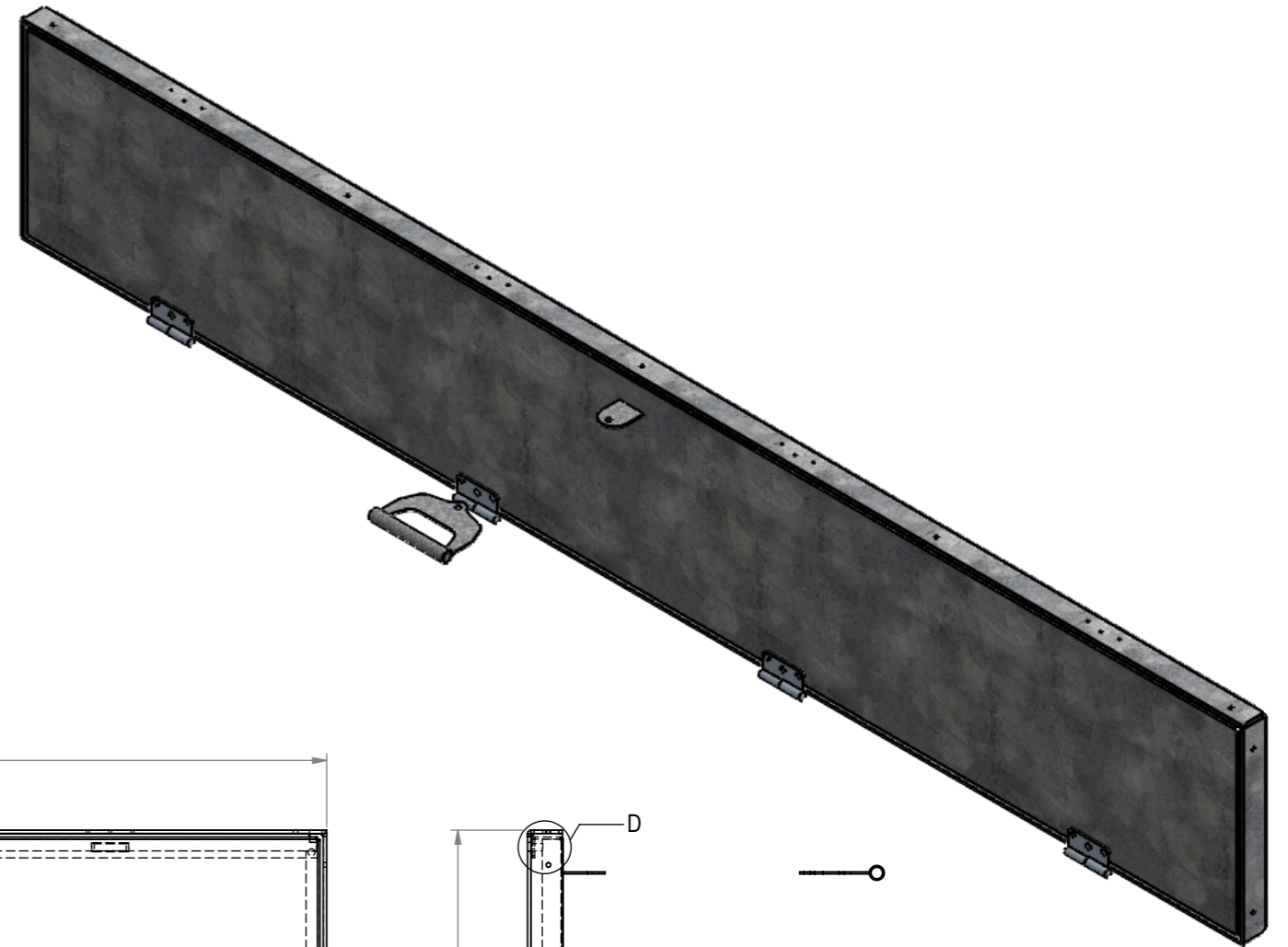

För hålmått i vägg 2500x400  
Yttermått ram = 2490x390  
Fritt mått när luckan är öppen = 2430x330

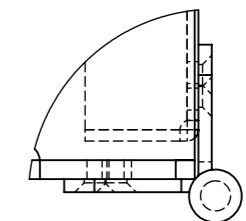
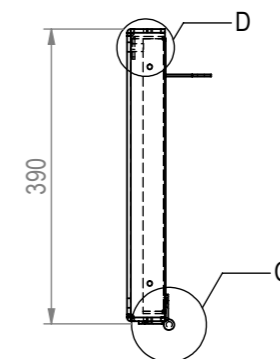
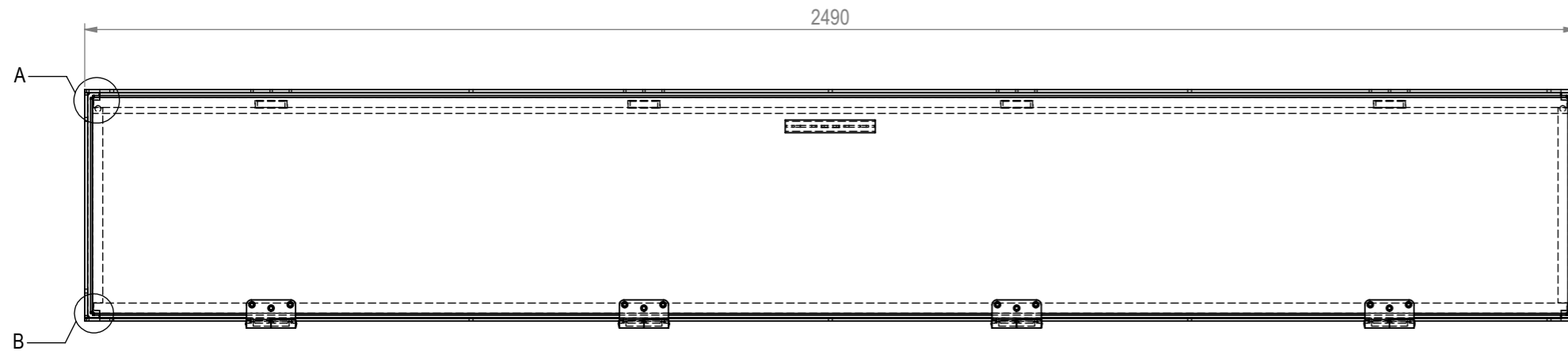

DETAIL C  
SCALE 1 : 2

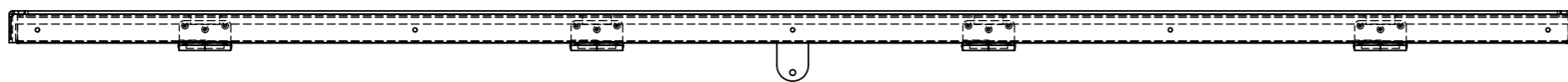

Elkington



CLIENT:			
TITLE:			
ORDER N°:			
SITE ID:			
Quantity:	Finish:	DWG N°:	WALL-COVER-FRAME-OF-2490X390
Material: ASSEMBLY			
Weight: 44.20	Treatment:	Date: 14/10/2022	

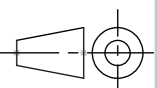

A3

Drawn:

SHEET 1 OF 1